

Portable CD Player

AZ 9235



Let's make things better.



PHILIPS

Es necesario que lea cuidadosamente su instructivo de manejo.

	PRECAUCIÓN - ADVERTENCIA	
	No abrir, riesgo de choque eléctrico	
	ATENCIÓN	
Verifique que el voltaje de alimentación sea el requerido para su aparato		
Para evitar el riesgo de choque eléctrico, no quite la tapa. En caso de requerir servicio, dirijase al personal calificado.		

Descripción:	Tocadiscos de CD portatil
Modelo:	AZ 9235/01, AZ 9235/16
Alimentación:	110-127/220-240 V~ 50-60 Hz
Consumo:	4 W (AY 3170)
Importador:	Philips Mexicana, S.A. de C.V.
Domicilio:	Norte 45, # 669, Col. Industrial Vallejo
Localidad y Telefono:	C.P. 02300 México D.F., Tel. 5728 4200
Exportador:	Philips Electronics Hong Kong, Ltd.
País de Origen:	China

Nº de Serie: _____

**LEA CUIDADOSAMENTE ESTE INSTRUCTIVO
ANTES DE USAR SU APARATO.**

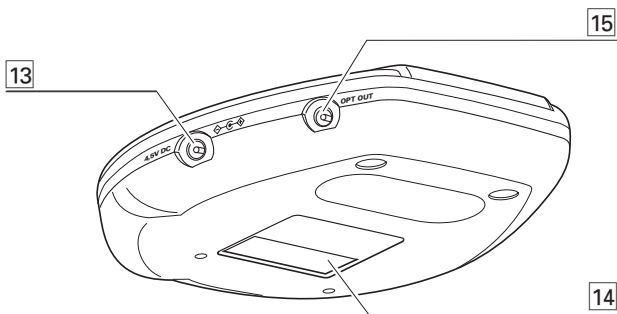
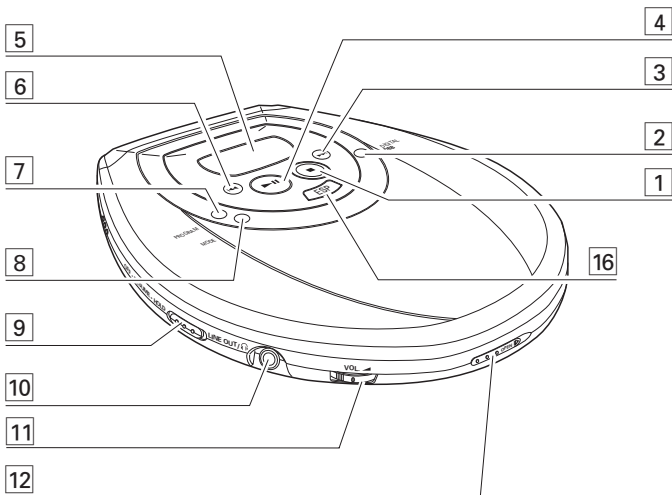

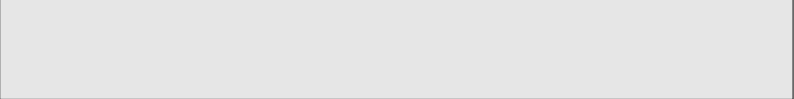

English	CD play 11–12
Controls 6	Features 13–18
Quick start 7	In-car connection 19
Power supply 8–10	Troubleshooting 20–21
Headphones 10	General information 22

English

Français	Ecouteurs 28
Informations générales 23	Lecture CD 29–30
Commandes 24	Caractéristiques 31–36
Mise en service rapide 25	Raccordement en voiture 37
Alimentation électrique 26–28	Pannes et remèdes 38–39

Français

Español	Reproducción de un CD 45–46
Controles 40	Características 47–52
Encendido rápido 41	Conexión al automóvil 53
Alimentación eléctrica 42–44	Localización de averías 54–55
Auriculares 44	Información general 56

Español

中文	Headphones 62
General information 57	CD play 63–64
Controls 58	Features 65–70
Quick start 59	In-car connection 71
Power supply 60–62	Troubleshooting 72–73

中文

Guarantees	Guarantee and service for
Polizia de garanția	New Zealand 78
Mexico 74–75	Garantia e Assistência Técnica
Philips product warranty for	Brasil 79
Australia 76–77	

CONTROLS, refer to the illustration on page 3

- 1 ■stops CD play, clears a program or switches the player off
- 2 DIGITAL DBB ...DIGITAL **DYNAMIC BASS BOOST** switches the bass enhancement on and off
- 3 ►►skips and searches CD tracks forwards
- 4 ►||switches the player on, starts or pauses CD play
- 5display
- 6 ◀◀skips and searches CD tracks backwards
- 7 PROGRAMprograms tracks and reviews the program
- 8 MODEselects the different playing possibilities: **SHUFFLE**, **SHUFFLE REPEAT ALL**, **REPEAT**, **REPEAT ALL** and **SCAN**
- 9 RESUMEstores the last position of a CD track played
HOLD**locks all buttons**
OFFswitches RESUME and HOLD off
- 10 LINE OUT/🔊3.5 mm headphone socket, socket to connect the player to another analogue audio input of an additional appliance, remote control socket (not on all versions)
- 11 VOL ◀adjusts the volume
- 12 OPEN ►opens the CD lid
- 13 4.5V DCsocket for external power supply
- 14typeplate
- 15 OPT OUT(not on all versions) socket to connect the player to digital equipment (e.g. a CD recorder) with a DIGITAL OPTICAL IN/AUX socket
- 16 ESP**ELECTRONIC SKIP PROTECTION** ensures continuous CD playback regardless of vibrations and shocks

Note: After every key operation the display is illuminated for a few seconds (not on all versions).

This set complies with the radio interference requirements of the European Community.

QUICK START

1 OPEN

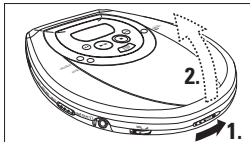

2 BATTERY

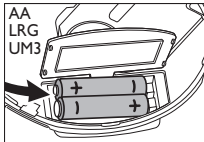
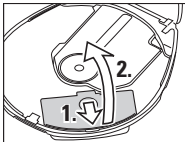

3 CD

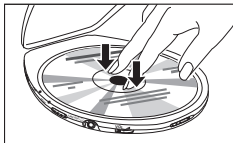

4 HEADPHONES

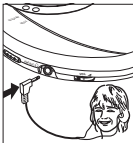

5 HOLD → OFF

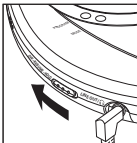

6 PLAY

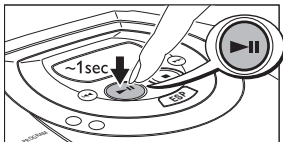

7 VOLUME

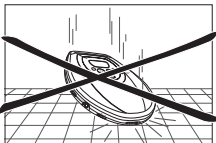
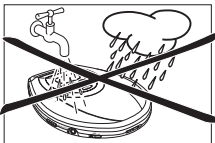
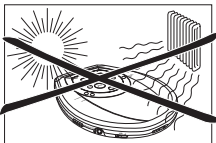
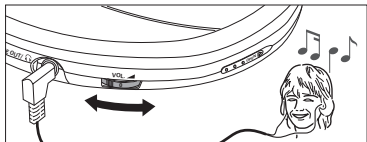

CAUTION

Use of controls or adjustments or performance of procedures other than herein may result in hazardous radiation exposure or other unsafe operation.

POWER SUPPLY

Batteries (supplied or optionally available)

With this player you can use either:

- normal batteries type **LR6**, **UM3** or **AA** (preferably Philips), or
- alkaline batteries type **LR6**, **UM3** or **AA** (preferably Philips).

Notes: – Old and new or different types of batteries should not be used in combination.

– Remove batteries if they are empty or if the player is not going to be used for a long time.

Inserting batteries

- 1 Push OPEN ► to open the CD lid.
- 2 Open the battery compartment and insert either 2 normal or alkaline batteries.

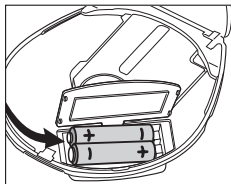

Battery indication

The battery symbol on the display is divided into 3 sections which indicate the approximate power capacity of the batteries.

- If  is flashing and bAtt is displayed, the batteries are empty.

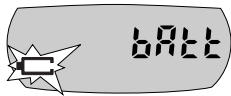

Average playing time of batteries under normal conditions

Battery type	ESP on	ESP off
Normal	7 hours	6 hours
Alkaline	22 hours	19 hours
ECO-PLUS NiMH batteries (not on all versions)	10 hours	9 hours

Batteries contain chemical substances, so they should be disposed of properly.

ECO-PLUS NiMH battery information (for versions supplied with rechargeable ECO-PLUS NiMH batteries AY 3362 only)

Recharging works only on players with supplied rechargeable ECO-PLUS NiMH batteries AY 3362.

Recharging the ECO-PLUS NiMH batteries on board

1 Make sure you insert the rechargeable ECO-PLUS NiMH batteries AY 3362.

2 Connect the mains adapter to the 4.5V DC socket of the player and to the wall socket.

→  filled with 0–3 sections (depending on the level of charge) is shown and *CHARGE* is displayed.



- Recharging stops when you start playback or when approximately 7 hours have passed by.

3 When the batteries are fully recharged,  is shown and *FULL* is displayed.



Notes: – It is normal for the batteries to become warm during recharging.

– If the batteries become too warm, recharging will be interrupted for approximately 30 minutes and *Halt* is displayed.

– To ensure proper recharging on board, take care that contacts are clean, and you are using only the ECO-PLUS NiMH batteries AY 3362.

Rechargeable ECO-PLUS NiMH battery handling

- Recharging already charged or half-charged batteries will shorten their lifetime. Therefore, after using the rechargeable ECO-PLUS NiMH batteries a few times, discharge them completely before recharging.
- To avoid a short circuit, the batteries should not touch any metal objects.
- When the batteries quickly become empty after recharging, the contacts are dirty or the end of their lifetime has been reached.

POWER SUPPLY/HEADPHONES

Mains adapter (supplied or optionally available)

Use only the AY 3170 adapter (4.5 V/300 mA direct current, positive pole to the centre pin). Any other product may damage the player.

- 1 Make sure that the local voltage corresponds to the mains adapter's voltage.
- 2 Connect the mains adapter to the 4.5V DC socket of the player and to the wall socket.

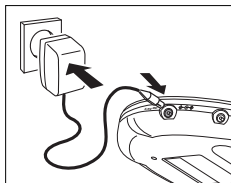

Note: Always disconnect the adapter when you are not using it.

Headphones HE 545

- Connect the supplied headphones to the LINE OUT/🔊 socket.

Note: LINE OUT/🔊 can also be used for connecting your HiFi system (signal lead) or your car radio (cassette adapter or signal lead). In both cases, the volume of the player must be set to position 8.

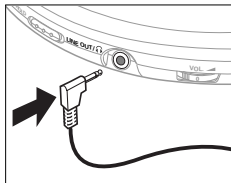

Use your head when using headphones

Hearing safety: Do not play your headphones at a high volume. Hearing experts advise that continuous use at high volume can permanently damage your hearing.

Traffic safety: Do not use headphones while driving a vehicle. It may create a hazard and it is illegal in many countries. Even if your headphones are an open-air type designed to let you hear outside sounds, do not turn up the volume so high that you cannot hear what is going on around you.

Playing a CD

This CD player can play all kinds of **Audio Discs** such as CD-Recordables and CD-Rewritables. Do not try to play a CD-ROM, CDi, VCD, DVD or computer CD.

- 1 Push the OPEN ► slider.
→ The lid opens.

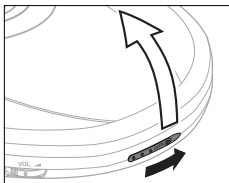

- 2 Insert an audio CD, printed side up, by pressing gently on the CD centre so that it fits onto the hub. Close the lid by pressing it down.

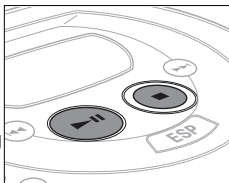

- 3 Press ►|| for approximately 1 second to switch the player on and start CD playback.
→ The current track number and the elapsed playing time are displayed.

- You can pause playback by pressing ►||.
- The time where playback was paused is flashing.
- Continue playback by pressing ►|| again.



- 4 Press ■ to stop playback.
→ The total number of tracks and the total playing time of the CD are displayed.



- 5 Press ■ again to switch the player off.
- To remove the CD, hold it by its edge and press the hub gently while lifting the CD.

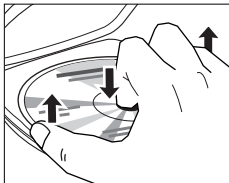

Note: If there is no activity, the set will automatically switch off after a while to save energy.

CD PLAY

Playback information

- If a recordable CD (CD-R) or a rewritable CD (CD-RW) is not recorded properly, *no disc* is displayed. In that case use **FINALIZE** on your CD recorder to complete the recording.
- If you want to play a rewritable CD (CD-RW), it takes 3–15 seconds for sound reproduction to start once you have pressed **▶II**.
- Playback will stop if you open the CD lid.
- While the CD is read, *1 - - -* is flashing.

Volume and bass

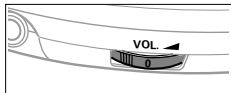

Volume adjustment

- Adjust the volume by using VOL .



Bass adjustment

You can choose between the bass enhancement levels *dbb 1* and *dbb 2*.

- 1 Press **DIGITAL DBB** as often as necessary to select the desired bass intensity.
→ *dbb 1* or *dbb 2* is displayed for 2 seconds and  is shown.
- 2 To switch *dbb 1* or *dbb 2* off, press **DIGITAL DBB** repeatedly.
→  goes off.

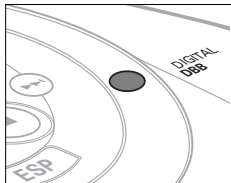

Selecting a track and searching

Selecting a track during playback

- Briefly press ◀◀ or ▶▶ once or several times to skip to the current, previous or next track.
 - Playback continues with the selected track and its number is displayed.

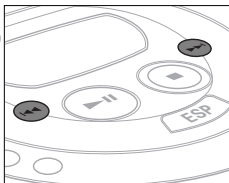

Selecting a track when playback is stopped

- 1 Briefly press ◀◀ or ▶▶ once or several times.
 - The selected track number is displayed.
- 2 Press ▶|| to start CD play.
 - Playback starts with the selected track.

Searching for a passage during playback

- 1 Keep ◀◀ or ▶▶ pressed to find a particular passage in a backward or forward direction.
 - Searching is started and playback continues at low volume. After 2 seconds the search speeds up.
- 2 Release the button when you reach the desired passage.
 - Normal playback continues from this very position.

Notes: – During SCAN searching is not possible.
 – During SHUFFLE, SHUFFLE REPEAT ALL, REPEAT or while playing a program, searching is only possible within the particular track.

FEATURES

Programming track numbers

You can select up to 99 tracks and store them in memory in a desired sequence. Any track can be stored more than once.

- 1 While playback is stopped, select a track with ◀◀ or ▶▶.
 - 2 Press PROGRAM to store the track.
 - PROGRAM lights up; the track number programmed and P with the total number of stored tracks are displayed.
 - 3 Select and store all desired tracks in this way.
 - 4 Press ▶▶ to start playback of your selected tracks.
 - PROGRAM is shown and playback starts.
- You can review the program by pressing PROGRAM for more than 2 seconds.
 - The display shows all stored tracks in sequence.

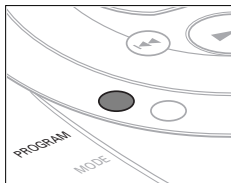

Notes: – If you press PROGRAM and there is no track selected, 5 E L E C t is displayed.
– If you try to store more than 99 tracks, F U L L is displayed.

Clearing the program

- 1 If necessary, press ■ to stop playback.
- 2 Press ■ to clear the program.
 - CLEAR is displayed once, PROGRAM goes off and the program is cleared.



Note: The program will also be cleared if you

- interrupt the power supply or
- open the CD lid,
- or if the set switches off automatically.

Storing the last position played – RESUME

You can store the last position played. When restarting, playback continues from where you have stopped.

- Switch the slider to RESUME during playback to activate RESUME.
→ **RESUME** is shown.
 - Press ■ whenever you want to stop playback.
 - Press ►|| whenever you want to resume playback.
→ **RESUME** is shown and playback continues from where you have stopped.
- To deactivate RESUME, switch the slider to OFF.
→ **RESUME** goes off.

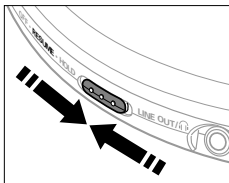

Locking all buttons – HOLD

You can lock the buttons of the set. When a key is pressed, no action will be executed then.

- Switch the slider to HOLD to activate HOLD.
→ All buttons are locked. *Hold* is displayed by pressing any key. If the set is switched off, *Hold* is displayed only by pressing ►||.
- To deactivate HOLD, switch the slider to OFF.

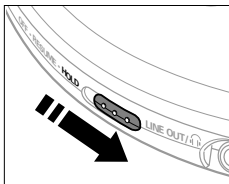

Note: When you deactivate HOLD by switching the slider to RESUME and restart, playback continues from where you have stopped.



FEATURES

ESP

With a conventional portable CD player you might have experienced that the music stopped e.g. when you were jogging. The **ELECTRONIC SKIP PROTECTION** prevents loss of sound caused by light vibrations and shocks. Continuous playback is ensured.

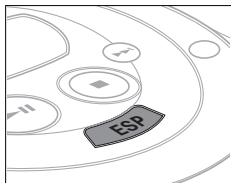
However, ESP does not prevent playback interruptions during serious running. It also does not protect the set against any **damage** caused **by dropping!**



- Press ESP during playback to activate the skip protection.
 -  is shown and the protection is activated.
- To deactivate the skip protection, press ESP again.
 -  goes off and the protection is deactivated.



Selecting different playing possibilities – MODE

It is possible to play tracks in random order, to repeat a track or the CD and to play the first few seconds of each track.

- 1 Press MODE during playback as often as necessary until the display shows either:
 - **SHUFFLE**: All tracks of the CD are played in random order until all of them have been played once.
 - **SHUFFLE REPEAT ALL**: All tracks of the CD are played repeatedly in random order.
 - **REPEAT**: The current track is played repeatedly.
 - **REPEAT ALL**: The entire CD is played repeatedly.
 - **SCAN**: The first 10 seconds of each of the remaining tracks are played in sequence.

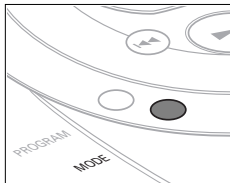



- 2 Playback starts in the chosen mode after 2 seconds.
 - To return to normal playback, press MODE repeatedly until the display indicator goes off.

FEATURES

Remote control (not on all versions)

Use the AY 3767 cord remote control. The buttons on the remote control have the same functions as the corresponding buttons on the CD player.

- 1 If necessary press **■** once or twice until the set is switched off.
- 2 Firmly connect the remote control to LINE OUT/ and the headphones to the remote control's socket.
- 3 Turn the volume down with VOL  on the remote control and set VOL  on the CD player to position 8.

Optical out (not on all versions)

You can connect your CD player to digital equipment (e.g. a CD recorder) with a DIGITAL OPTICAL IN/AUX socket.

- 1 Use the mains adapter, switch ESP off and turn down the volume of the appliance that should be connected.
 - 2 Connect an optical cable or signal lead to the OPT OUT socket of your CD player and to the DIGITAL OPTICAL IN/AUX socket of the other appliance.
- To adjust volume and sound, use the controls of the connected appliance.

Notes: – For analogue connections use the LINE OUT/ socket.

– Playback via OPT OUT does not work if the player is supplied by batteries.

IN-CAR CONNECTION

In-car use (connections supplied or optionally available)

Only use the AY 3545 car voltage converter (4.5 V, DC, positive pole to the centre pin) and the AY 3501 car cassette adapter. Any other product may damage the set.

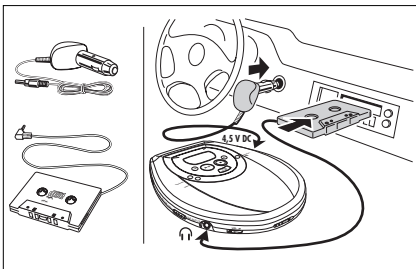

- 1 Put the CD player on a horizontal, vibration-free and stable surface. Make sure it is in a safe place, where the player is neither a danger nor obstacle to the driver and passengers.
 - 2 Connect the DC plug of the voltage converter to the 4.5V DC socket of the CD player (**only for a 12 V car battery, negative grounding**).
 - 3 Insert the voltage converter into the cigarette lighter socket. If necessary, clean the cigarette lighter socket to obtain a good electrical contact.
 - 4 Turn down the volume and connect the cassette adapter plug to the LINE OUT/🔊 socket of the CD player.
 - 5 Carefully insert the cassette adapter into the car radio's cassette compartment.
 - 6 Make sure the cord does not hinder your driving.
 - 7 Start the CD player, set VOL \blacktriangleleft to position 8 and adjust the sound with the car radio controls.
- Always remove the voltage converter from the cigarette lighter socket when the CD player is not in use.

Notes: – Avoid excessive heat from the car heating or from direct sunlight (e.g. in a parked car in the summer).

– If your car radio has a LINE IN socket, it is better to use it for the car radio connection instead of the cassette adapter. Connect the signal lead to this LINE IN socket and to the LINE OUT/🔊 socket of the CD player.

TROUBLESHOOTING

WARNING

Under no circumstances should you try to repair the set yourself as this will invalidate the guarantee.

Problem	Possible cause	Solution
No power, playback does not start	Batteries Batteries inserted incorrectly	Insert the batteries correctly.
	Batteries are empty.	Change the batteries.
	Contact pins are dirty.	Clean them with a cloth.
	Mains adapter Loose connection	Connect the adapter securely.
nF dISC indication	In-car use Cigarette lighter is not powered when ignition is off.	Switch on ignition or insert batteries.
	CD-RW (CD-R) is not recorded properly.	Use FINALIZE on the CD recorder to complete the recording.
	The CD is badly scratched or dirty.	Replace or clean the CD.
no dISC indication	CD is not or incorrectly inserted.	Insert a CD, label upwards.
	The laser lens is steamed up.	Wait until the lens has cleared.
HOLD indication and/or no reaction to controls	HOLD is activated. Electrostatic discharge	Deactivate HOLD. Disconnect the set from power supply or take out the batteries for a few seconds.

TROUBLESHOOTING

If a fault occurs, first check the points listed, before taking the set for repair.

If you are unable to solve a problem by following these hints, consult your dealer or service centre.

Problem	Possible cause	Solution
The CD skips tracks.	The CD is damaged or dirty.	Replace or clean the CD.
	RESUME , SHUFFLE or PROGRAM is active.	Switch RESUME , SHUFFLE or PROGRAM off.
No sound or bad sound quality	PAUSE is activated.	Press ▶II .
	Loose, wrong or dirty connections	Check and clean connections.
	Volume is not adjusted.	Adjust the volume.
	Malfunctions due to vicinity of active mobile phones	Keep the player away from active mobile phones.
	Strong magnetic fields near the player	Change the player's position or connections.
	In-car use	
	cassette adapter is inserted incorrectly.	Insert the cassette adapter correctly.
	Temperature inside the car is too high/low.	Let the player adjust to the temperature.
Cigarette lighter socket is dirty.	Clean the cigarette lighter socket.	
Wrong playback direction of the car cassette player's autoreverse feature	Change the autoreverse direction.	

GENERAL INFORMATION

CD player and CD handling

- Do not touch the lens (A) of the CD player.
- Do not expose the set, batteries or CDs to humidity, rain, sand or excessive heat (caused by heating equipment or direct sunlight).
- You can clean the CD player with a soft, slightly dampened, lint-free cloth. Do not use any cleaning agents as they may have a corrosive effect.
- To clean the CD, wipe it in a straight line from the centre towards the edge using a soft, lint-free cloth. A cleaning agent may damage the disc! Never write on a CD or attach a sticker to it.
- The lens may cloud over when the set is moved suddenly from cold to warm surroundings. Playing a CD is not possible then. Leave the CD player in a warm environment until the moisture has evaporated.
- Active mobile phones in the vicinity of the CD player may cause malfunctions.
- Avoid dropping the set as this may cause damage.

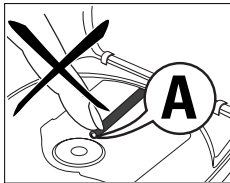

Environmental information

- All redundant packing material has been omitted. We have done our utmost to make the packaging easily separable into two mono materials: cardboard (box) and polyethylene (bags, protective foam sheet).
- Your set consists of materials which can be recycled if disassembled by a specialized company. Please observe the local regulations regarding the disposal of packing materials, exhausted batteries and old equipment.